

400 SERIES

WING TYPE O-BORE

Designed for easy attachment to vessels and docks.

Drill and bolt fender to structure using the integral wings.

Eliminates need for mounting holes on the facing. Offered in three EPDM colors: black, non-marking grey and white.

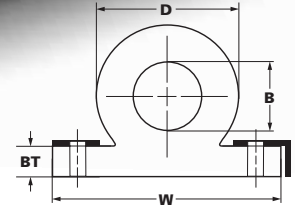
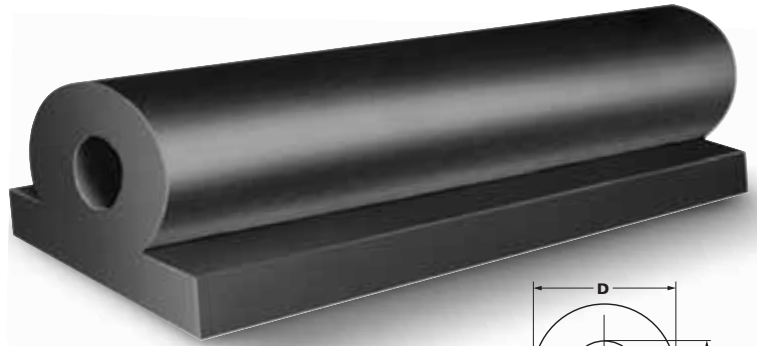

CODE NO.	DURAMAX® PART NO.	BASE WIDTH (W)	BASE THICKNESS (BT)	OUTSIDE DIAM. (D)	BORE DIAM.	WT./FT.	LENGTH UP TO
DB-404	802040401	4"	1/2"	2 1/2"	1"	2.8 LBS.	60 FT.
DB-405	802040501	5"	1/2"	2 1/2"	1"	3.1 LBS.	60 FT.
DB-406	802040601	6"	3/4"	3"	1"	4.9 LBS.	60 FT.
DB-407	802040701	6 1/2"	1"	4"	2"	7.1 LBS.	60 FT.
DB-408	802040801	6 1/2"	1"	4"	1"	8.3 LBS.	20 FT.
DB-409	802040901	9"	1 1/2"	6"	3"	15.3 LBS.	20 FT.
DB-409A	802040911	9"	1 1/2"	6"	2"	17.4 LBS.	20 FT.
DB-410	802041001	9 1/2"	1 1/2"	6"	2"	17.7 LBS.	20 FT.
DB-412	802041201	12"	2"	8"	4"	27.2 LBS.	20 FT.
DB-416	802041601	16"	2 1/2"	10"	4"	47.5 LBS.	20 FT.
DB-418	802041801	18"	3"	12"	6"	61.2 LBS.	10 FT.

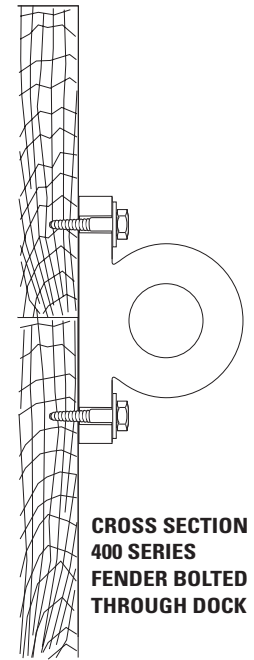
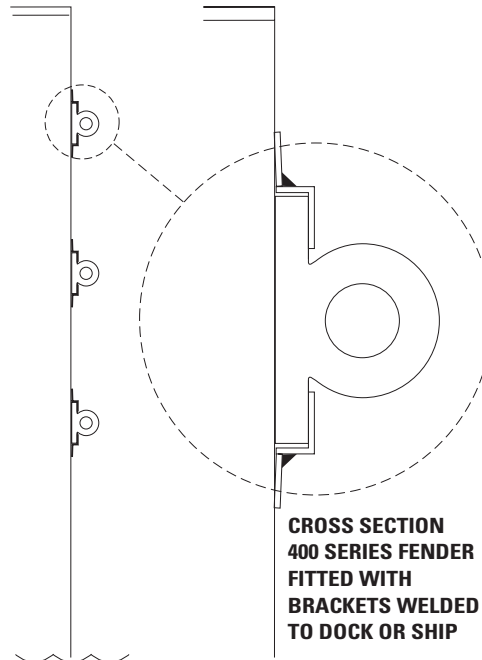
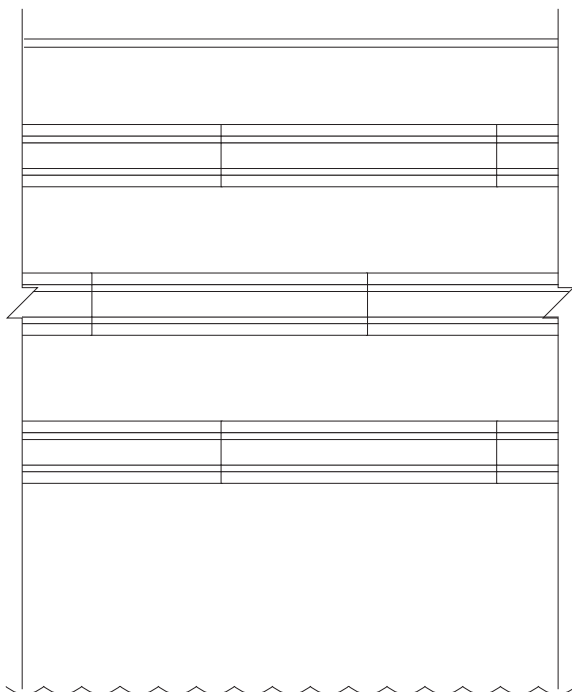

400 SERIES (CONTINUED)

WING TYPE SOLID

Manufactured in black, non-marking grey and white EPDM

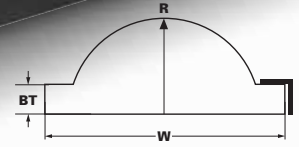
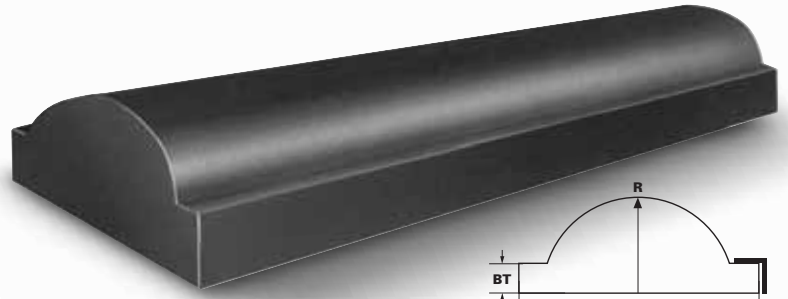

CODE NO.	DURAMAX® PART NO.	BASE WIDTH (W)	BASE THICKNESS (BT)	RADIUS (R)	WT./FT.	LENGTH UP TO
DB-460	802046001	10"	1 1/4"	4"	14.6	20 FT.

WING TYPE SOLID/D-BORE

WING TYPE D-BORE

Manufactured in black, non-marking grey and white EPDM

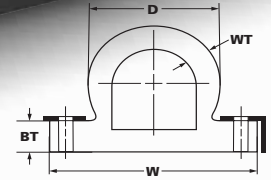

CODE NO.	DURAMAX® PART NO.	BASE WIDTH (W)	BASE THICKNESS (BT)	OUTSIDE DIAM. (D)	WALL THICKNESS (WT.)	WT./FT.	LENGTH UP TO
DB-440	802044001	9 1/2"	1 1/2"	6"	1"	14.9 LBS.	20 FT.

